



ELECTRONIC BYPASS VALVE

INSTALLATION INSTRUCTIONS

Direct Drive Version RM-2-50-1555-4

©2019 Restomod Air / 08.19

RESTOMOD AIR 
ULTIMATE STYLE. KILLER PERFORMANCE.

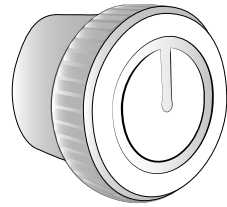

Control Knob

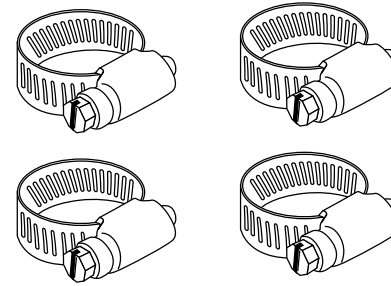

Worm Gear Clamps (4)
PN#6274 IDEAL

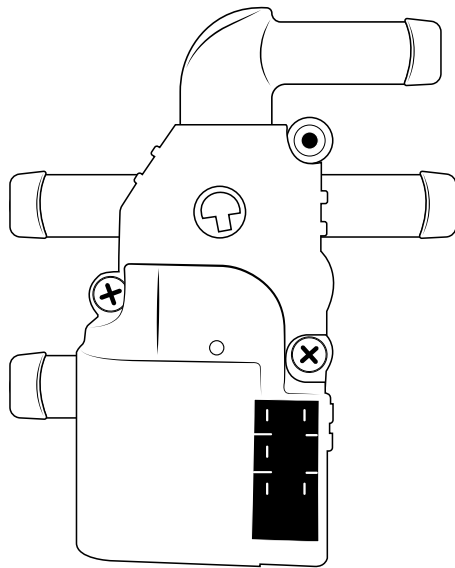

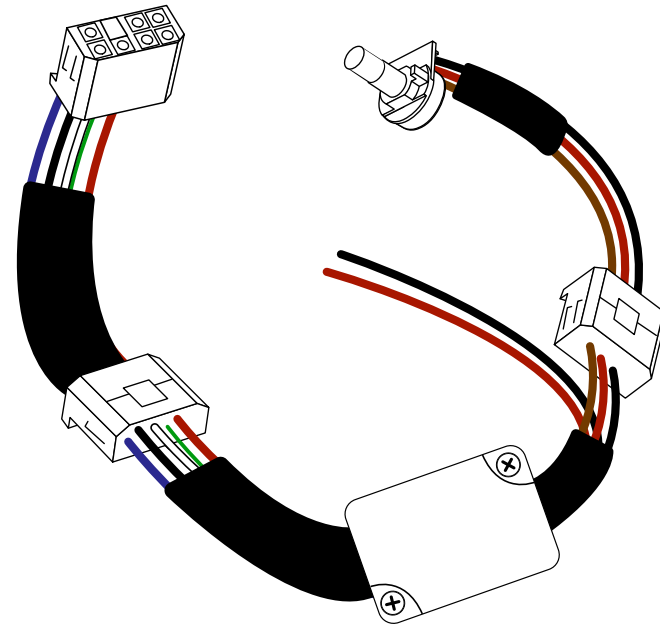

Electronic Water Valve



Direct Drive Harness





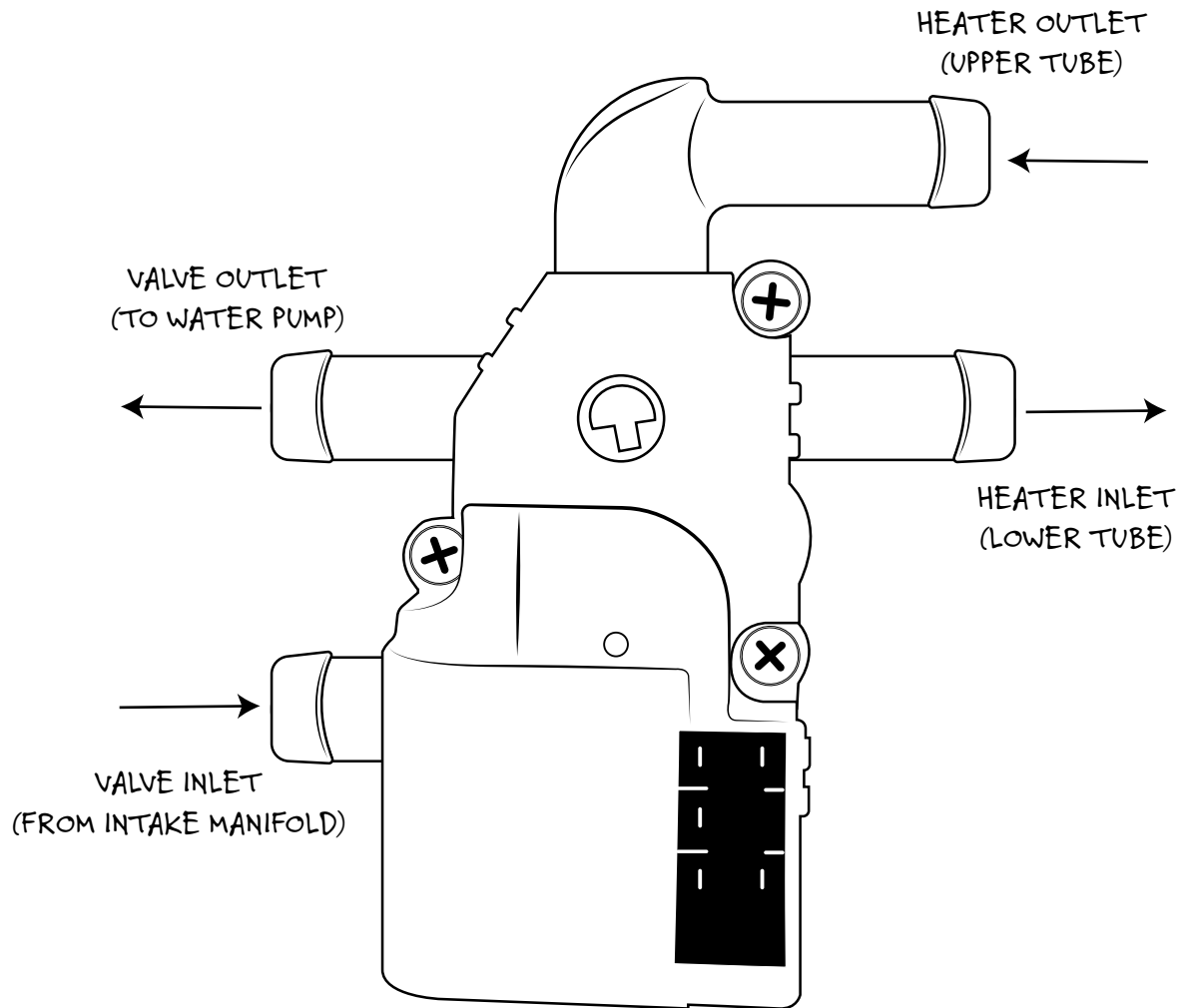

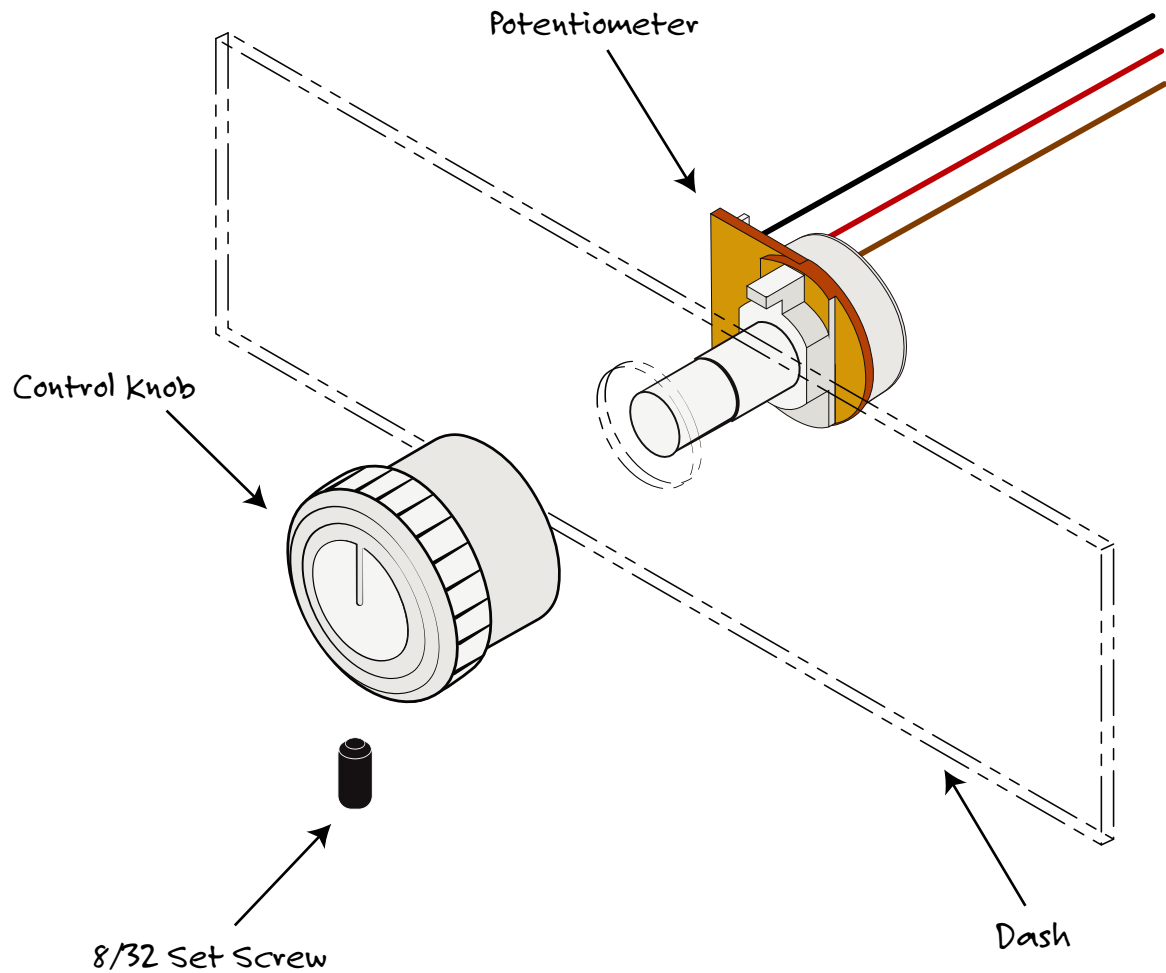
Mount Water Valve:

-  Locate an area for water valve to be mounted.
-  Route heater hoses according to the Diagram pictured.
-  Set Water valve in desired location and tighten heater clamps.





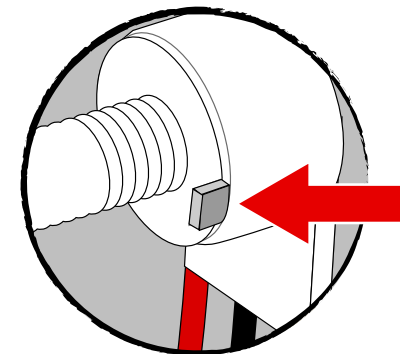

Mount Control Knob:

-  Locate an area for Control Knob to be mounted.
-  Drill hole according to the Diagram pictured.
-  Mount Potentiometer through hole just drilled.
-  Tighten set screw on Potentiometer
-  Red power wire on Direct Drive Harness must go to 10 amp fuse.
-  tab on the side of the rotary switch that you might want to remove so that the switch can sit flush with the back side of your dash

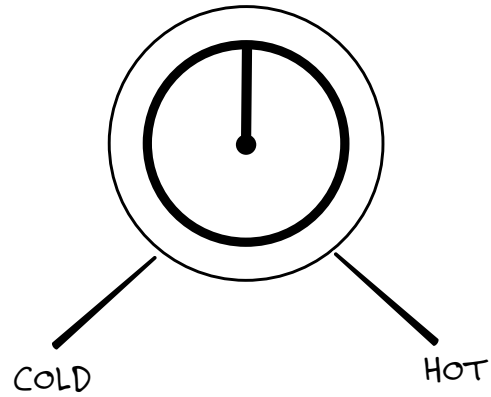



Control Knob:

-  Turn Control Knob to the right to make water valve HOT.
-  Turn Control Knob to the left to make it water valve COLD.

