

Haymaker - S

INSTALL MANUAL

©RESTOMOD AIR 08.22

HAYMAKER-S OVERVIEW

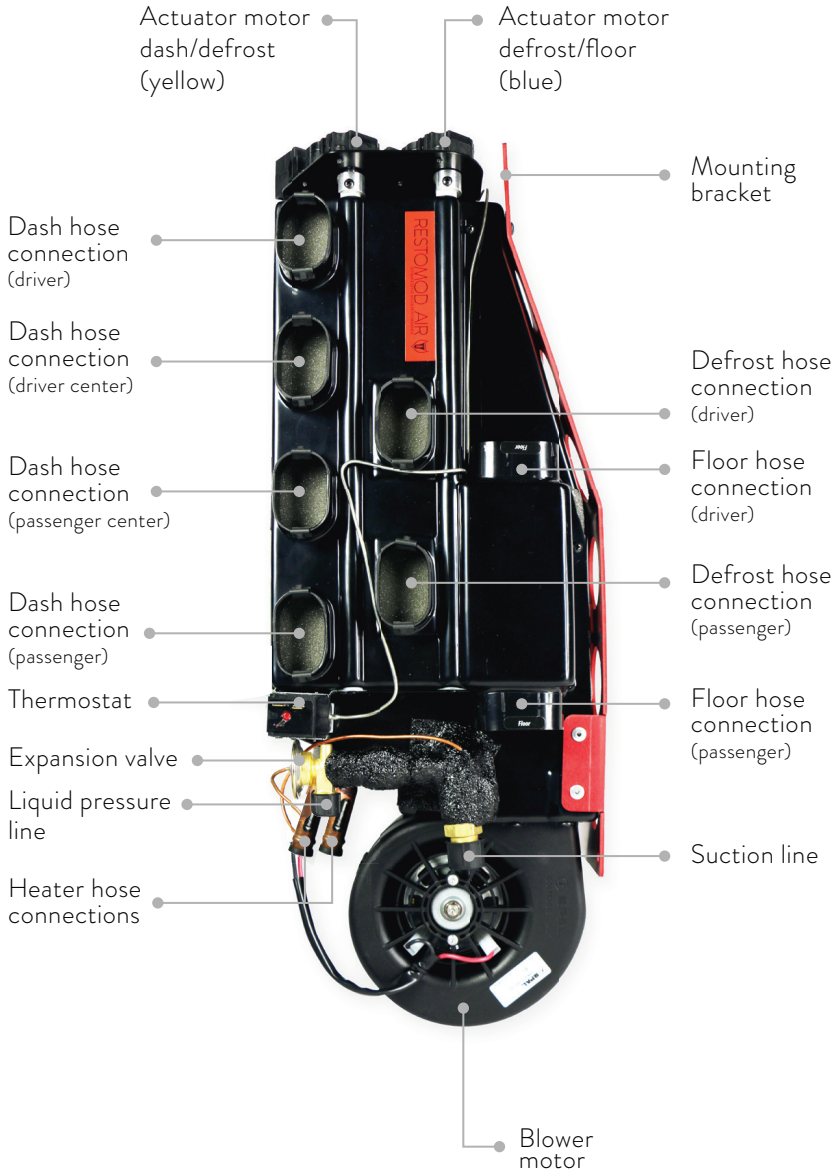

HAYMAKER-S FEATURES

The Haymaker-S is made specifically for full-size vehicles with large interiors.

FUNCTION OF HAYMAKER - S

Air conditioning and heat with infinite blend of dash, defrost and floor.

ROTARY
clockwise

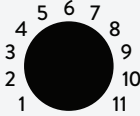

LINEAR
left to right



FAN	
POSITION	SPEED
1	OFF
2-10	VARIABLE
11	HIGH

MODE				
POSITION	DASH	DEFROST	FLOOR	COMPRESSOR
1	100%	0%	0%	ON
2	80%	20%	0%	ON
3	60%	40%	0%	ON
4	40%	60%	0%	ON
5	20%	80%	0%	ON
6	0%	100%	0%	ON
7	0%	80%	20%	ON
8	0%	60%	40%	ON
9	0%	40%	60%	ON
10	0%	20%	80%	ON
11	0%	0%	100%	ON

TEMPERATURE	
HEATER VALVE	COMPRESSOR
CLOSED	ON
10%	ON
20%	ON
30%	ON
40%	ON
50%	ON
60%	ON
70%	ON
80%	ON
90%	ON
OPEN	OFF

CHANGING AIR POSITIONS

The Haymaker-S allows for blending air positions and temperatures. When turning mode knob clockwise, air will blend from dash to defrost by activating the yellow servo motor. When continuing the rotation of the knob clockwise, the air will blend from defrost to floor by activating the blue servo motor.

CHANGING AIR TEMPERATURES

When turning temp knob clockwise, temperature will increase from cold to hot. Like modern vehicles, the compressor is active in all mode positions to allow temperature blending by adding heat with the temperature knob. Compressor is off in full heat position.

MULTI-MOUNT

Our exclusive multi-mount system allows you to mount your Haymaker-S without the need to fab any bracket for your firewall with 4 different options. If your firewall has a indentation for the trans tunnel, use the included multi-mount extension bracket to offset your unit.

BLUETOOTH

The Haymaker-S works with your mobile device by establishing a secure Bluetooth connection to provide instantaneous wireless control and feedback. Download the app from the Apple app store or Google Play store.

SWITCH TECHNOLOGY

Switch Technology allows you to bounce back and forth between the app, hard control and remote controls. Yes, you can have multiple ways to control your Haymaker-S.

INSTALL CHECKLIST

✓	PAGE	DESCRIPTION
<input type="checkbox"/>	04-05	Plan your install
<input type="checkbox"/>	06	Mount Haymaker-S
<input type="checkbox"/>	09	Install drain tube
<input type="checkbox"/>	10	Attach hoses
<input type="checkbox"/>	11	Wrap #10 suction hose fitting with refrigerant tape
<input type="checkbox"/>	05	Mount ECU
<input type="checkbox"/>	12	Connect output harness to ECU & servos
<input type="checkbox"/>	12	Connect main power harness to ECU & blower motor
<input type="checkbox"/>	12	Locate 12v ignition source
<input type="checkbox"/>	12	Ground ECU
<input type="checkbox"/>	05	Mount controls
<input type="checkbox"/>	12	Connect input harness from controls and ECU
<input type="checkbox"/>	13	Mount defrost and run ducting
<input type="checkbox"/>	13	Mount floor ducts and run ducting
<input type="checkbox"/>	13	Mount dash vents and run ducting
<input type="checkbox"/>	14	Calibrate unit

PLANNING INSTALL



If your vehicle has been or is being modified, some procedures will need to be adjusted to fit your particular application. Read below before cutting/drilling. Since this is a custom installation that will vary based on your particular vehicle, many of our procedures can be viewed as suggestions. Your personal preferences will play a major role in the actual installation.

LOCATION OF THE UNIT

The Haymaker-S is designed for vehicles that have “flat/shaved/smoothed” firewalls. If you have not done this you might want to make a firewall plate before starting the install.

- leave a min. of 1½”-2” above unit for dash and defrost duct hose connections
- leave a min. of 6“-9” right of the unit for a/c and heater hoses to enter the engine bay
- keep in mind ECU wires are designed to mount near the a/c unit
- make sure unit is level

LOCATION OF THE DRAIN TUBE

IMPORTANT

Condensation forms when the compressor is active. Water exiting the evaporator uses gravity to evacuate. Water does not travel upwards.

- location of the drain tube hole must be below the unit
- use the supplied grommet + 90° elbow to create a tight seal

TIP Most custom installers will not want the water exit to be on the firewall and choose the passenger kick panel instead. Make sure water actually exits the kick panel area and it does not collect in the cavity between inner kick panel and outer fender.

LOCATION OF HOSES TO ENGINE COMPARTMENT

- the Haymaker-S has heater + a/c connections
- use bulkhead plate as a drill template
- if using grommets: seal around hoses tightly to prevent engine/outside air + moisture entering the cabin
- when tightening fittings, make sure to use a backup wrench
- do not overtighten fittings (o-rings will crush or tear)
- after attaching hoses to evaporator, apply refrigerant tape to hose fittings on the evaporator to keep condensation from dripping on passenger floor board
- We have supplied fittings that work for most applications but if you need a different fitting, let's swap. Give us a call.

While bulkhead plates create a visually appealing connection, they are important because they create a positive seal from engine bay conditions such as: moisture, heat and fumes. If you are not using a bulkhead, make certain to seal around hoses and use grommets to avoid premature failure caused by vibrations and friction. Seal all holes/seams or anything else that will allow engine/outside air to enter the cabin. Failing to do so will prevent a/c unit to perform at it's highest ability.

TIP If room allows, we recommend mounting heater/water control valve on the interior of the vehicle for cleaner install.

LOCATION OF ECU

- ECU must be mounted near the unit with the supplied self tapping screws

Do not extend wires on (output) harness. Doing this will change resistance valves and will not allow your unit to function properly.

TIP Make sure grounds of system are amazing. An incorrectly functioning system is typically attributed to a bad grounding (engine ground, body ground, battery ground) in the vehicle wiring.

LOCATION OF CONTROLS

- locate a spot that looks killer - but also functional
- before cutting, make certain wires will connect to the ECU location
- make sure dash cavity will allow for control depth when mounted
- make sure nothing will interfere with control function

LOCATION OF DEFROST

When running defrost ducting, make certain to cycle the windshield wipers. Duct hose can be damaged by moving wiper arms.

- use supplied zip ties to secure duct hose to unit + defrost

IMPORTANT

We have several different shapes and sizes of defrost diffusers. Get the size that fits, defrost is a safety issue!

LOCATION OF FLOOR DUCTS

The Haymaker-S is designed for large vehicles so we have provided 2 floor heat dumps. Heat is non-directional so location isn't that important just make sure the air is pointed towards driver & passenger footwell. Kick panel areas are prime locations for heat dumps.

- use the supplied self tapping screws to attach to vehicle
- use supplied zip ties to secure duct hose to unit + floor ducts

LOCATION OF VENTS

- plan two vents for the driver and two vents for the passenger
- vents must be mounted where the air will be felt on passengers - odd locations such as kick panels are not ideal
- use supplied zip ties to secure duct hose to unit + vents

The location of a/c vents are the single most important decision to be made during planning & install. Remember, a/c IS directional. Placement of vents is critical to comfort for driver & passenger. The vent must be close to occupant or they will not be cool & comfortable.

TIP Adding vents does **not** mean better air flow and removing vents does **not** mean better airflow. Adding vents does not magically give you more air, life is not that simple. The Haymaker-S is engineered to use 4 dash vents. Use them.



USING THE MULTI-MOUNT

The multi-mount system allows you to mount your unit flush with the inside smoothed/shaved/flat firewall - use the included extension mounting bracket to offset your unit if needed.

FLAT FIREWALL

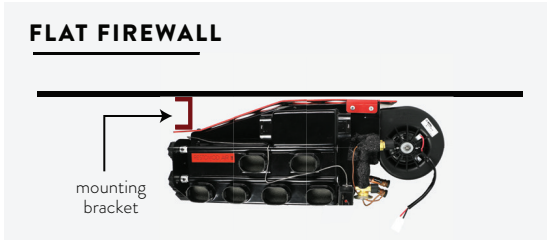

CURVED FIREWALL

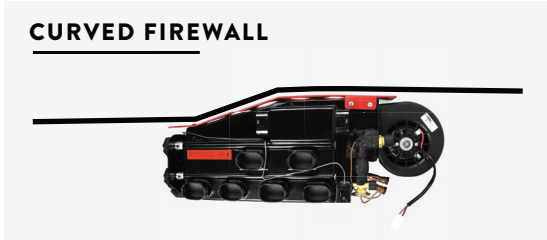

LARGE CURVED FIREWALL



MOUNTING
POINT

MOUNTING
POINT



MOUNTING
POINT

MOUNTING
POINT

STANDARD - WELD STUDS

Weld studs are provided for vehicles with unpainted firewalls. If your firewall is painted, refer to the bolt option below.

Level the Haymaker-S. Mark the mounting points of the multi mount bracket. Using the marked points, weld the mounting studs. Place Haymaker-S on the studs and secure with 1/4 x 20 nuts.

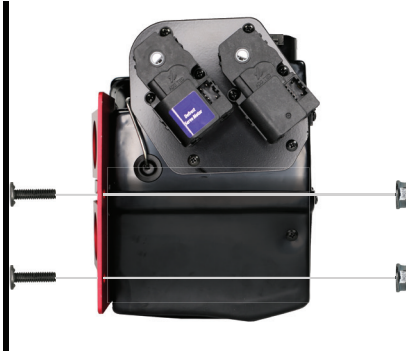

STANDARD - BOLTS

Stainless steel cap screws and flange nuts are provided for painted vehicles where installers do not mind having 4 bolt heads showing in the engine compartment.

Level the Haymaker-S. Mark the mounting points of the multi mount bracket. Using the marked points, drill the holes for the bolts. Mount the Haymaker-S using bolts.

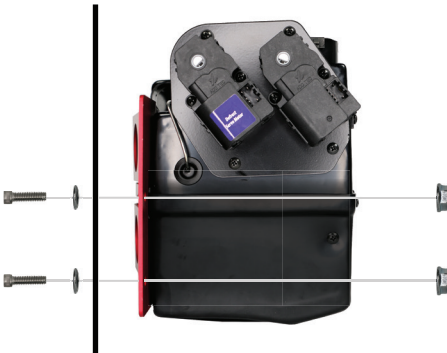



VEHICLE MOUNTING

FIREWALL MOUNTING

The most common place to mount the Haymaker-S is on the firewall behind the glove box opening. Use one of the options to mount our multi mount bracket system. Reference pages 06-07.

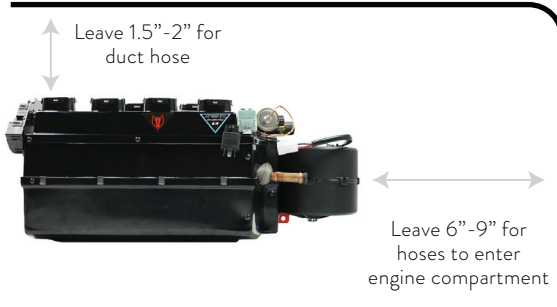

CUSTOM COWL MOUNTING

In some situations, installers do not want to mount to a painted firewall. We recommend mounting from the inner cowl area found on some vehicles. Build a bracket that will “hang” the Haymaker-S from above and secure from side to side movement. **More than one bracket will be needed.**

IMPORTANT

Beware: before mounting, make sure you are aware of what you are mounting to.

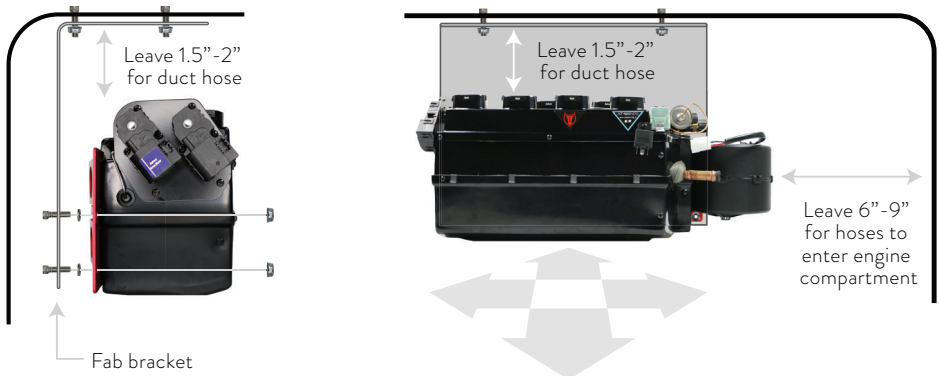

IMPORTANT

Make certain the Haymaker-S is secure from all movement.

DRAIN TUBE

IMPORTANT

It's crucial the drain tube is angled down for water to drain - water flows down!

FIREWALL

Locate the drain nipple on the Haymaker-S. Drill a 3/4" hole for the drain tube below the drain nipple. Attach 1/2" drain tube to evaporator nipple and run through the drilled hole. Use the supplied grommet and 90° elbow for the drain tube to exit.



KICK PANEL

Most custom installers will not want the water exit to be on the firewall and choose the passenger kick panel instead. Make sure water actually exits the kick panel area and it does not collect in the cavity between inner kick panel and outer fender.

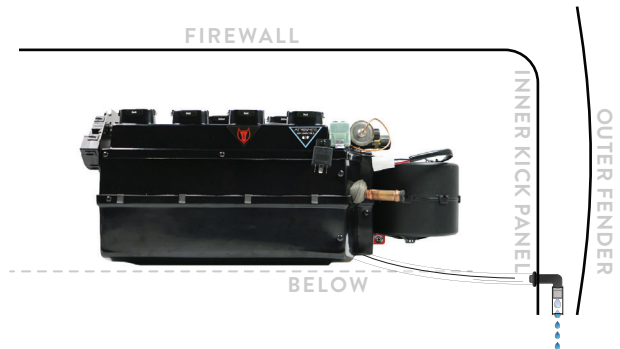



HOSES

FIREWALL WITH BULKHEAD/GROMMETS

Cut supplied hoses to length needed. The supplied a/c + heater fittings are for interior connections because we assume you bought one of our badass bulkheads. Use supplied large zip ties to secure hoses.

TIP Have fittings crimped by qualified shop or send back to us.



KICK PANEL WITH BULKHEAD/GROMMETS

Some installers choose to run hoses in the far fender area via the inner kick panel. Additional length hoses will be needed (not supplied.) You will have 2 seals when going through kick panel. Use supplied large zip ties to secure hoses.

TIP We recommend using grommets (not supplied) on the kick panel + bulkhead on the firewall.



IMPORTANT

- Make sure you seal all holes/seams or anything else that will allow engine or outside air to enter the cabin. Failing to do so will prevent a/c unit to perform at it's highest ability.
- Use 2 wrenches to tighten fittings. Do not over tighten. Use a few drops of mineral oil with every o-ring.



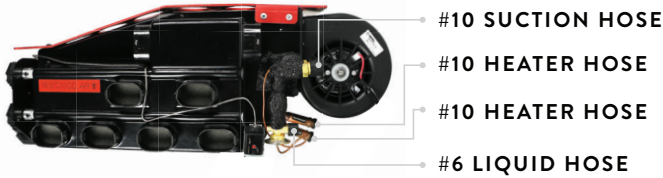

IMPORTANT

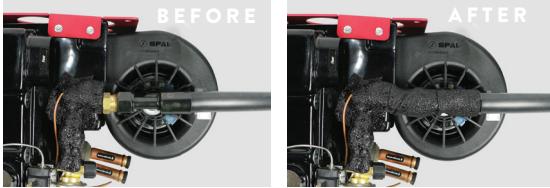

Make sure you wrap the #10 suction hose fitting on the Haymaker-S with refrigerant tape so condensation does not drip on the passenger floor board.

ELECTRIC WATER VALVE

Make sure the water valve is positioned correctly. **The water valve is a directional valve and should be installed with the arrow pointing towards the water pump.** If the water valve is connected to the incorrect hose, it allows water to circulate through the system via the heater core overpowering the cooling effect of the a/c coil. **Make certain the water valve goes to the water pump!**

IMPORTANT

It is **REQUIRED** that the water valve is on the return line and the arrow is pointed towards the water pump.

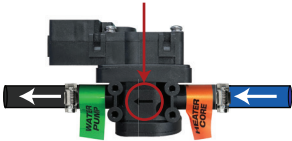

COYOTE ENGINES

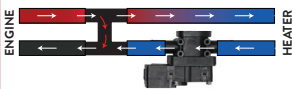

It is **REQUIRED** that the H pipe be mounted on the **ENGINE** side of the Water Valve in order to cycle water when water valve is **CLOSED**.

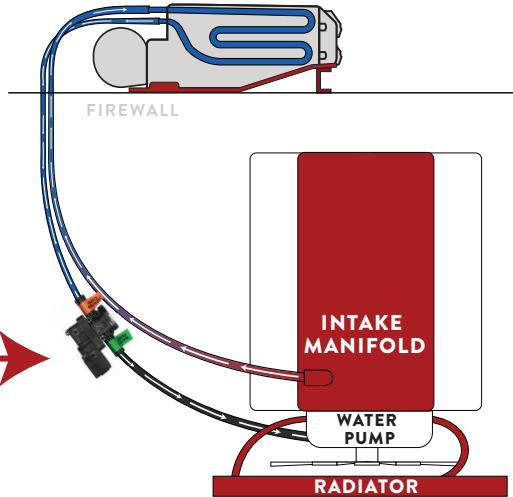

LS ENGINES ONLY

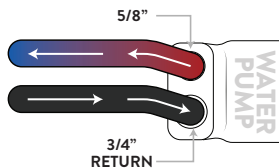

DEFROST + FLOOR DUCTS + VENTS

Use supplied zip ties to secure duct hose to defrost, floor ducts and vents. Cut duct hose to length needed. When cutting duct hose pull taut. Hose will stretch in summer months and possibly sag affecting the air flow.

TIP Make certain hose is not cut too loose where it is hanging. The smoother the routing of the flex hoses, the better the air flow.

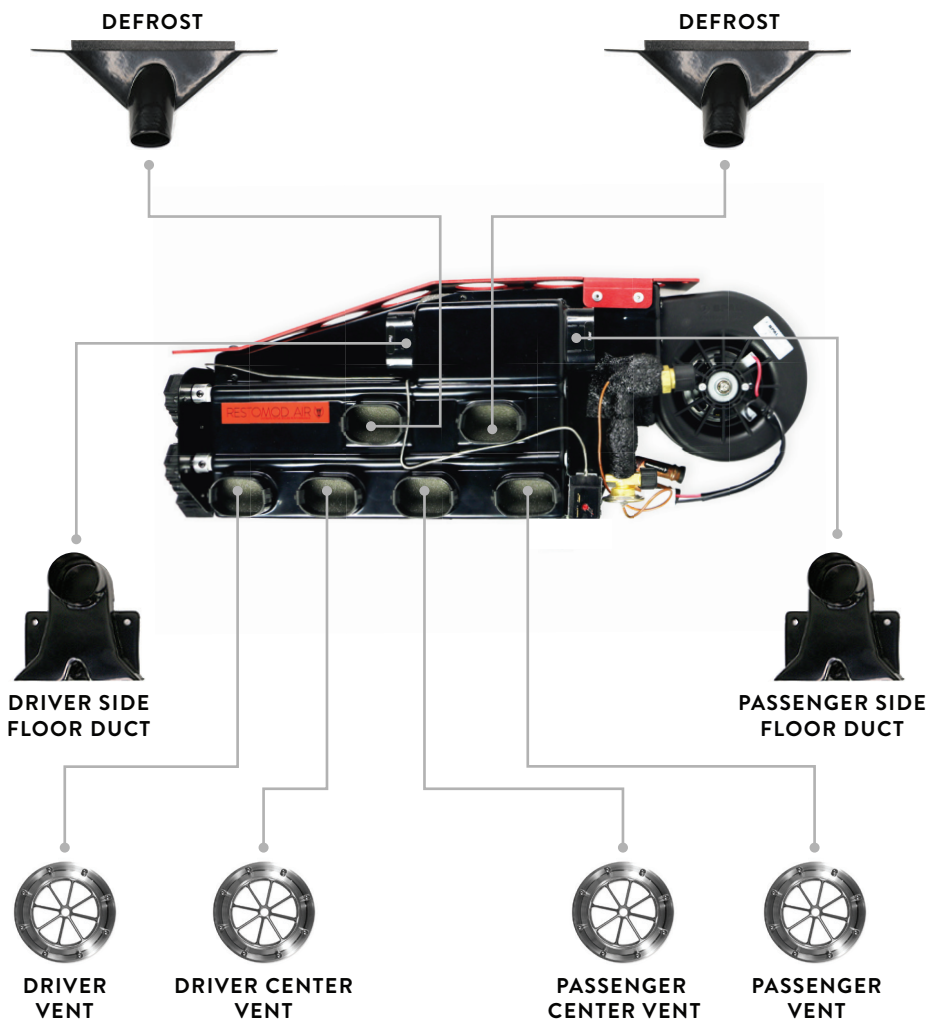

TIP

Work the duct hose on the adapter by squeezing the duct hose. Do not crush/pinch duct hose. Slight distortion is acceptable.

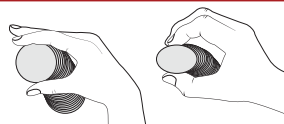



SYSTEM ECU DIAGNOSTICS

LED PHASES	
RED SOLID	Calibration mode
RED FLASH	Power to ECU
GREEN FLASH	Receiving bluetooth signal
BLUE FLASH	Low Voltage or Bad Ground

THE APP

Use your iOS or Android device to change your mode, temp, fan speed, check diagnostics and more. The Restomod Air app provides instantaneous wireless control and feedback of your a/c unit via bluetooth. Available for free in the Apple App store or Google Play.

ADVANCED SYSTEM DIAGNOSTICS

Check how your a/c system is functioning in the diagnostics screen. You can see the voltage, current temperature and position of control and motor for your temperature, mode and fan speed.

SWITCH TECHNOLOGY

Switch Technology allows you to bounce back and forth between the app, hard control and remote control.

CUSTOMIZE

Change your dial theme, highlight color, upload a photo to your background and more.

FREE TO DOWNLOAD



Apple App store

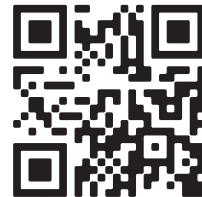

Google Play

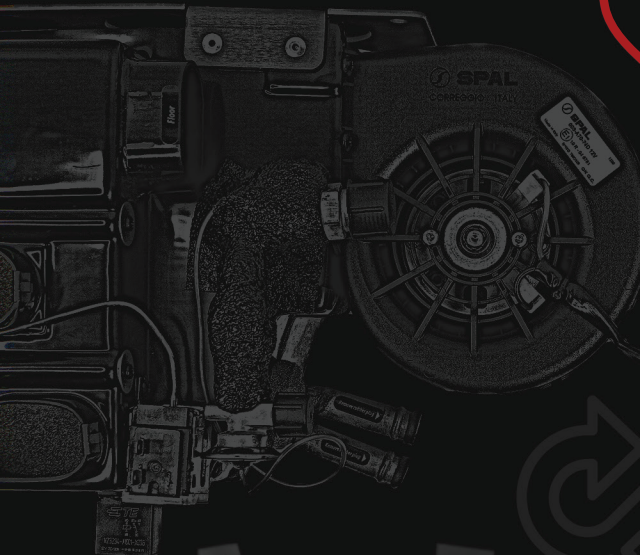

HEATER CORE

WATER PUMP



Haymaker - S

